



Feature :

Multiple keys and poles
Interlock and individual lock

Application :

Various switching purpose
Home electronic equipments
Industrial electronic equipments

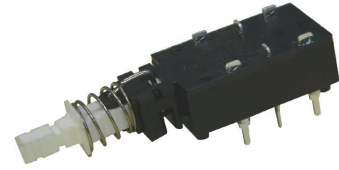

SWITCH SPECIFICATIONS	
POLE - POSITION	SPST , SPDT , DPST , DPDT are Available
CONTACT RATING	250 V AC , 4 A or 250 V AC , 8 A
CONTACT RESISTANCE	100 mΩ MAX. 1.5 V DC ; 100 mA , by Method of Voltage DROP
INSULATION RESISTANCE	500 MΩ MIN. 500 V DC
DIELECTRIC STRENGTH	Breakdown is not Allowable ; 1000 V AC for 1 Minute
OPERATING FORCE	600 ± 200 gf
OPERATING LIFE	10,000 cycles
OPERATING TEMPERATURE RANGE	-40°C ~ 85°C
TOTAL TRAVEL	TRAVEL : 2.0 ± 0.3 mm ; TOTAL TRAVEL : 4.5 ± 0.3 mm

▶ HOW TO ORDER

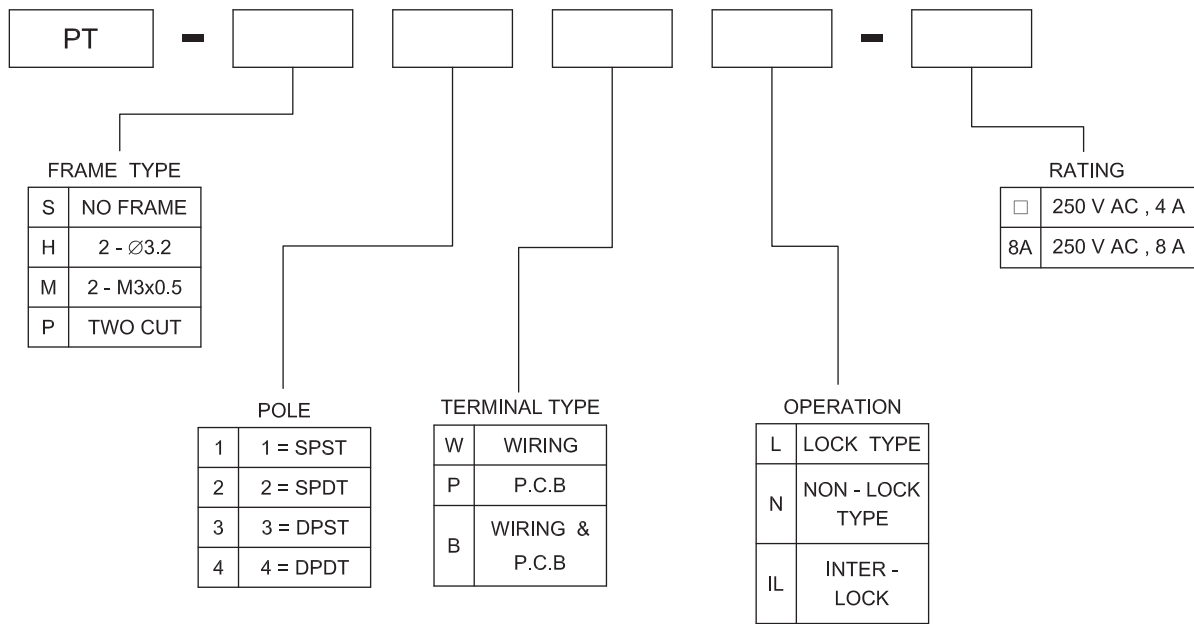

- TACT SWITCH
- PUSH BUTTON SWITCH
- LED TOUCH SENSOR SWITCH
- 5 DIRECTION NAVIGATION SWITCH WITH LED
- MEMBRANE SWITCH
- LED LIGHT BAR
- SLIDE SWITCH
- ROTARY SWITCH
- ROCKER SWITCH
- DETECT SWITCH
- ENCODER
- INTERRUPTER
- MINIATURE MICRO SWITCH
- TELEPHONE HOOK SWITCH
- DOOR SWITCH
- MINI SIZE SOCKET
- KNOB
- CAP SYMBOL



▶ FRAME TYPE

PT - S4PL

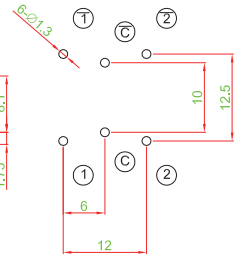
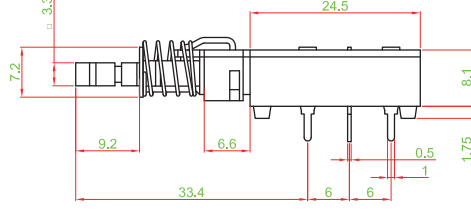
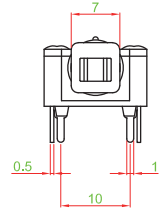
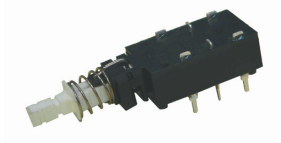

PT - H3WL

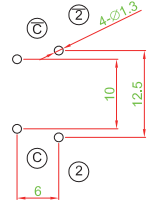
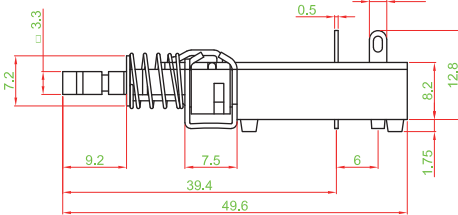
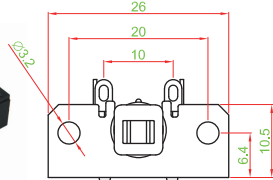
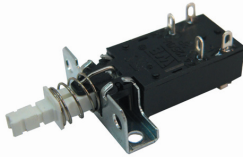

PT - M3BL

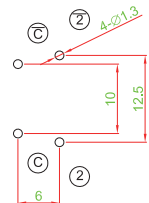
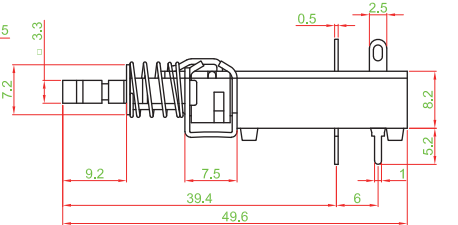
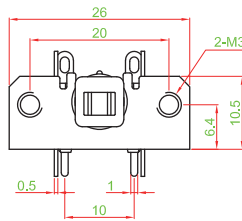
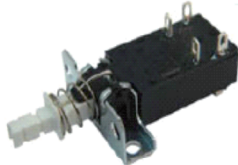

PT - P4PL

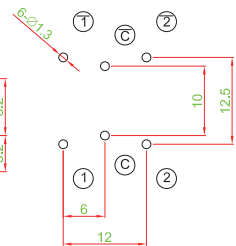
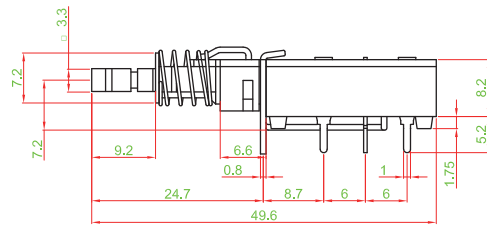
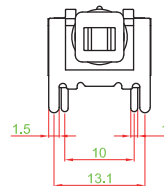

▶ CIRCUIT

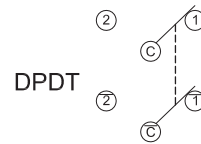
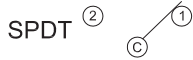

▶ INTER-LOCK & LENGTH

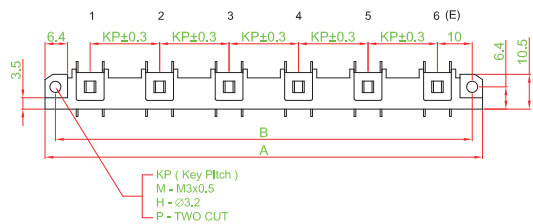

間距一覽表 (L尺寸) 單位: mm

Pitch	Size	間距一覽表 (L尺寸)											
		1	2	3	4	5	6	7	8	9	10	11	12
KP = 15	B	20	35	50	65	80	95	110	125	140	155	170	185
	A	26	41	56	71	86	101	116	131	146	161	176	191
KP = 17.5	B	—	37.5	55	72.5	90	107.5	125	142.5	160	177.5	195	212.5
	A	—	43.5	61	78.5	96	113.5	131	148.5	166	183.5	201	218.5
KP = 20	B	—	40	60	80	100	120	140	160	180	200	220	240
	A	—	46	66	86	106	126	146	166	186	206	226	246